



Canon

T70



INSTRUCTIONS  
English Edition





## Nomenclature

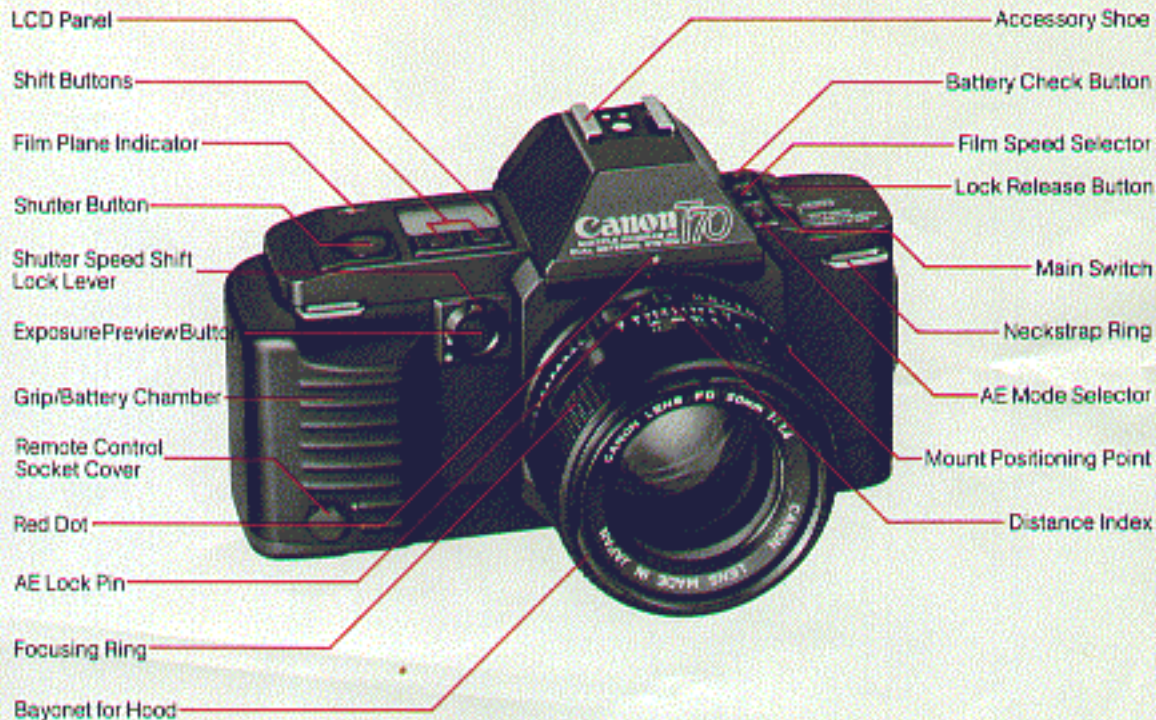

## INTRODUCTION

Thank you for purchasing the Canon T70. This camera carries automation several steps further than its predecessors, resulting in extreme picture taking ease and professional quality photographs.

Exposure information is displayed clearly in the easy-to-read LCD panel and push buttons make operation simple and smooth.

The T70 can be used in three programmed modes. In all of these modes, it is as easy to use as a compact camera because the aperture and shutter speed are chosen for you. Standard program is for general photography, Tele program chooses fast shutter speeds and Wide program chooses small apertures. The T70 can also be used in the shutter-priority and manual override modes.

Another important feature is the T70's ability to switch between two metering systems. Center-

weighted average metering is for evenly lighted subjects while selective area metering is good for backlit and other contrasting subjects.

To make film winding, rewinding, and loading easy, the T70 uses a built-in power winder which makes everything automatic.

Your picture taking options are further expanded by the T70's optional accessories: the Speedlite 277T and the Command Back 70. The 277T can be used in both programmed and F. NO. SET modes. The Command Back can be used to control the camera for long exposure and interval photography.

For instructions on initial photography, please read the "Basic Steps" section. After you have mastered those operations, move on to "Making the most of your T70" for further information that will assist you as your interest and skill in photography grow.



# Contents

## Basic Steps

1. Attaching the Lens	6
2. Setting the Lens for AE Photography	8
3. Loading the Batteries	8
4. Turning on the Camera	9
5. Checking the Batteries	10
6. Setting the Film Speed	11
7. Loading the Film	12
8. Selecting the Shooting Mode	15
9. Holding the Camera	16
10. Focusing	17
11. Shooting	18
12. Self-Timer Photography	20
13. Dedicated Flash Photography with the Canon 277T	22
14. Rewinding the Film	24
15. Carrying the Camera	26
16. Pre-shooting Checklist	27



While reading these instructions unfold the front and back flaps of this booklet for easy reference to the camera's parts.

# BASIC STEPS

## 1. Attaching the Lens

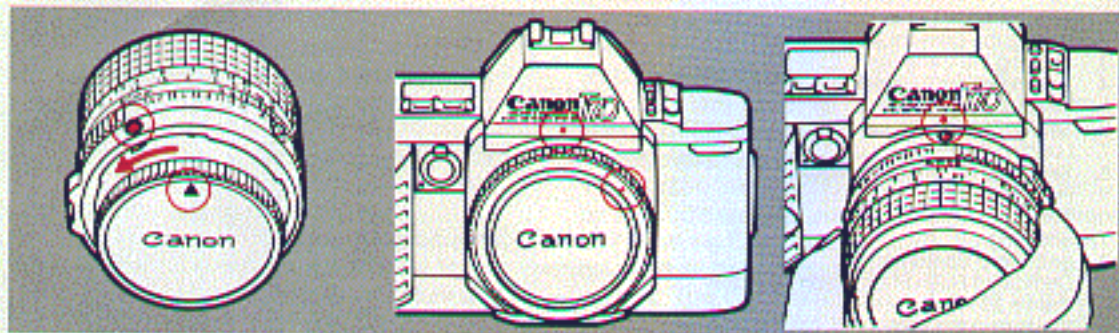

- 1) Turn the rear lens cap in the direction of the arrow until it stops and pull it off the lens. To reattach the rear lens cap, align its arrow with the red dot on the lens. Then lightly push it in and turn it clockwise until it stops.
- 2) Turn the body cap counter-clockwise and pull it off. To reattach the body cap, first align its red positioning point with the red dot above the camera mount, then turn the cap clockwise.
- 3) To mount the lens, first align the lens' mount positioning point with the camera's red dot.



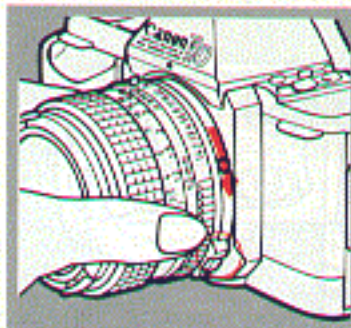

- 4) Then turn the lens clockwise until it stops and the lens release button pops out with a click.

To remove the lens, turn it counterclockwise while pressing the lens release button.

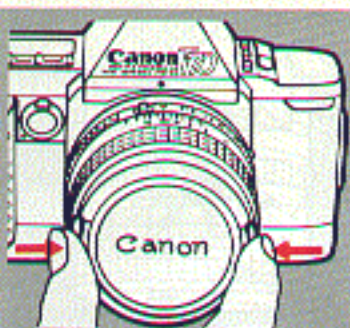

- 5) Remove the front lens cap.

Be sure to place the lens with its front end down (as illustrated) to avoid damaging the protruding pins.



## 2. Setting the Lens for AE Photography

## 3. Loading the Batteries

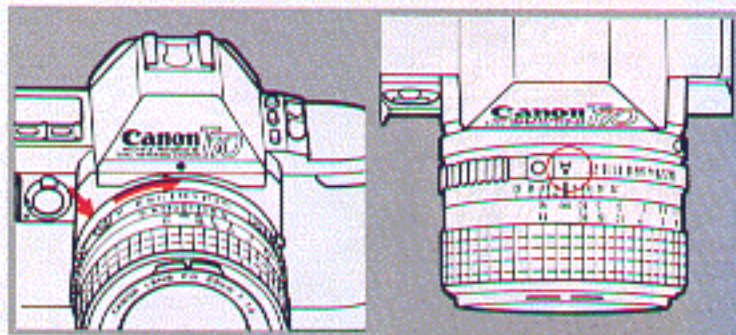

If the aperture ring is disengaged from the "A" mark, turn it in the direction of the arrow while pressing in the AE lock pin, until the "A" mark click-stops at the distance index.

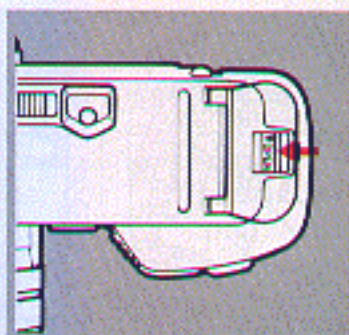

1) Push the battery chamber cover opening latch in the direction of the arrow and the battery chamber cover will flip open.



Refer to page 46 for photography when the aperture ring is disengaged from the "A" position.

- Use two new alkaline batteries (size AA, 1.5 V) of the same brand. Carbon-zinc and Ni-Cd batteries can also be used (See page 30).
- Remove the batteries if you do not expect to use the camera for about three weeks or longer.



#### 4. Turning on the Camera

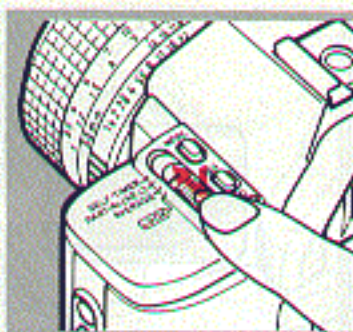
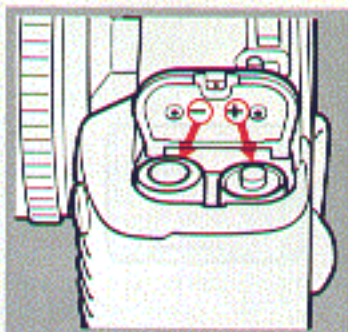

(example)

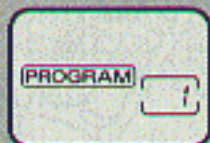

2) Load the batteries so that their terminals face in the directions indicated on the inside of the battery chamber cover. The camera will not function if the batteries are loaded incorrectly.

While pressing the lock release button, slide the main switch to AVERAGE from the LOCK position. The display will come on at this time.

Refer to page 35 for further information about AVERAGE and PARTIAL (AE L) operations

## 5. Checking the Batteries

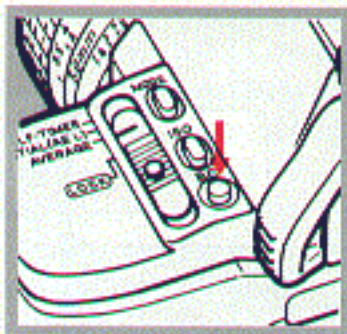

Press the battery check button. Battery voltage is then shown on the display panel.

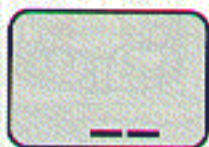
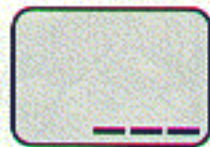

Battery power is sufficient.



Replace the batteries with new ones.





## 7. Loading the Film

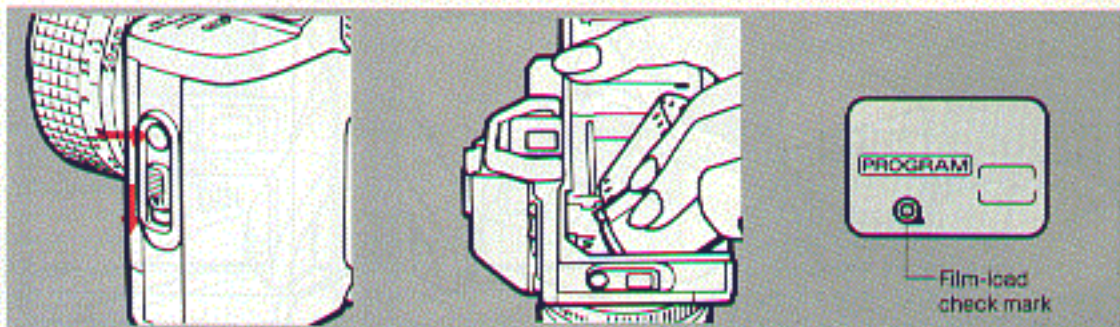

- 1) To open the back cover, push the back cover latch down, while pressing the back cover latch safety lock button in.
- 2) Place the film cartridge in the film chamber. A cartridge symbol will then appear on the display panel to indicate that film is loaded.

### CAUTION:

NEVER touch the shutter curtain, especially when loading the film. It is sensitive to pressure due to its high precision design.

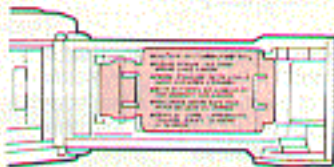

Before loading the first film cartridge, remove the plastic insert and throw it away.



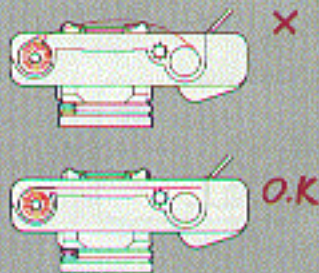
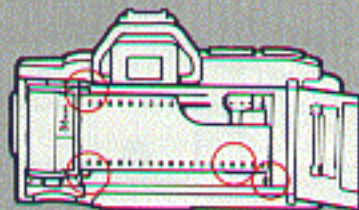
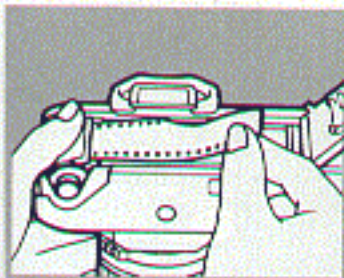

3) Pull out the film leader with your right hand, while holding the camera and the film with your left hand to hold the camera steady.

4) Make sure that ① the film tip is aligned with the orange index and that ② its perforations are properly engaged with the sprocket teeth.

If the film leader extends past the orange index, take out the film cartridge and manually wind the excess film back into the cartridge.

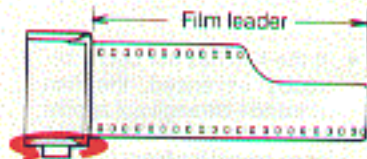

When the humidity is high, film becomes soft and easily torn. Keep the film stored in its canister until just before you load it to keep it from tearing.

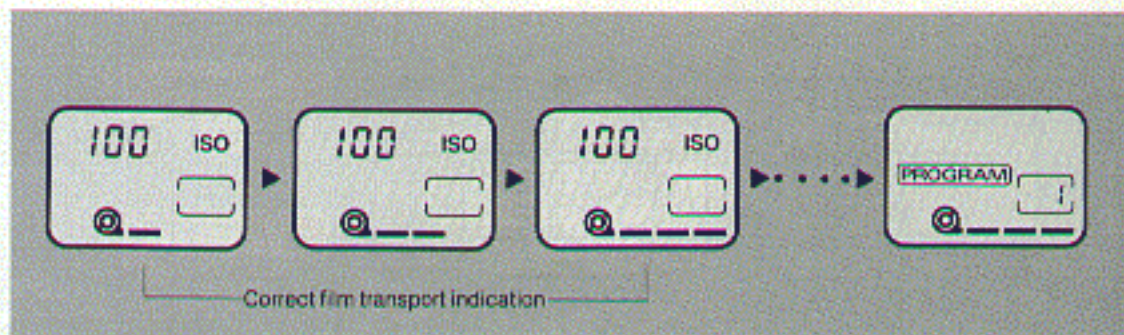

5) Close the back cover. The camera will advance the film automatically and stop when "1" appears in the frame counter brackets on the display panel. If the film is being

correctly advanced, three bars will appear at the bottom of the display panel moving in sequence from left to right away from the film cartridge display symbol.

- The preset film speed will appear on the display panel while the camera is advancing the film.
- If the film has not been correctly advanced, the film transport bars will not appear on the display panel. In that case, reload the film.



## 8. Selecting the Shooting Mode



While pressing the AE mode selector, press one of the shift buttons until "PROGRAM" appears on the panel.

When the camera is in the AE mode, the camera will automatically select the aperture and shutter speed for you. The camera will also automatically select the focus for you. The camera will also automatically select the white balance for you. The camera will also automatically select the ISO speed for you. The camera will also automatically select the metering mode for you. The camera will also automatically select the exposure mode for you. The camera will also automatically select the exposure mode for you.

When the camera is in the AE mode, the camera will automatically select the aperture and shutter speed for you. The camera will also automatically select the focus for you. The camera will also automatically select the white balance for you. The camera will also automatically select the ISO speed for you. The camera will also automatically select the metering mode for you. The camera will also automatically select the exposure mode for you. The camera will also automatically select the exposure mode for you.

Refer to pages 40–53 for further information about operation of the other modes.

## 9. Holding the Camera



The slightest body movement during shutter release may cause image blur (See page 60).

- 1) Hold the camera firmly, with your left hand supporting the camera and lens.
- 2) Press your left elbow close to your body.
- 3) Lightly press the camera against your cheek or forehead and look into the viewfinder.
- 4) Spread your feet slightly apart, one foot ahead of the other, and relax.

There is no one correct way to hold the camera, so experiment to find the most suitable way for you. Select a comfortable, stable method and, if possible, lean against a steady support such as a tree, wall, or table. It may help to practice in front of a mirror. This will help make your pictures sharper.



## 10. Focusing

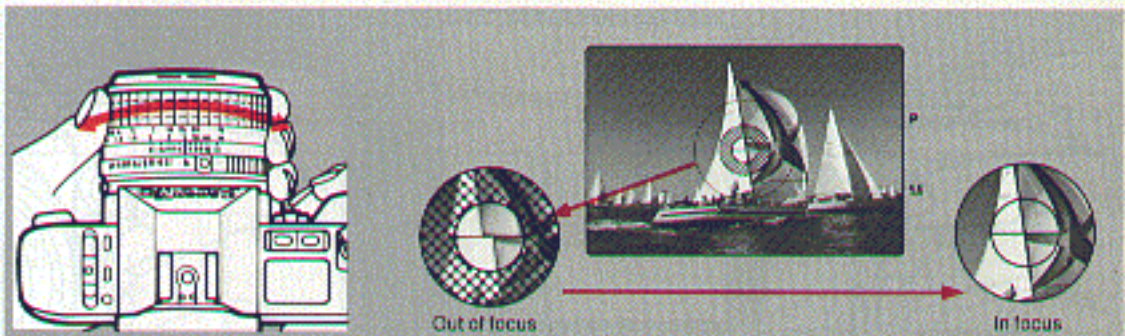

1) While looking into the viewfinder, turn the focusing ring until the main subject is sharp.

2) The subject is in focus when the upper and lower halves of the central split rangefinder merge to become one unbroken image.

10. Focusing

For further details, see page 34.

## 11. Shooting









1) Gently press the shutter button halfway or press the exposure preview button to check the exposure. If a solid green "P" and a solid red aperture number appear on the right side of the viewfinder, exposure will be correct.

2) Compose the picture and gently press the shutter button all the way. The film will be automatically advanced to the next frame.

- To take a single exposure, remove your finger from the shutter button as soon as the shutter is released.
- To take continuous exposures, just keep your finger on the shutter button for as many pictures as you wish to take.

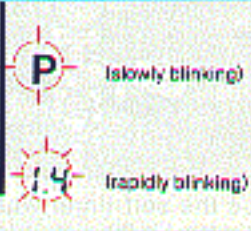

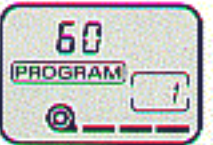
- If the subject is too dark or too bright, the following blinking warning marks will appear. (For details see pp. 44—45)

	When the subject is too bright.	Camera-shake warning	When the subject is too dark.
Indications in the viewfinder	 <p>(rapidly blinking)</p>	 <p>(slowly blinking)</p>	 <p>(slowly blinking) (rapidly blinking)</p>
Indications on the display panel	 <p>(slowly blinking)</p>		 <p>(slowly blinking)</p>

(When using the FD 80 mm 1:1.4 lens)

## 12. Self-Timer Photography

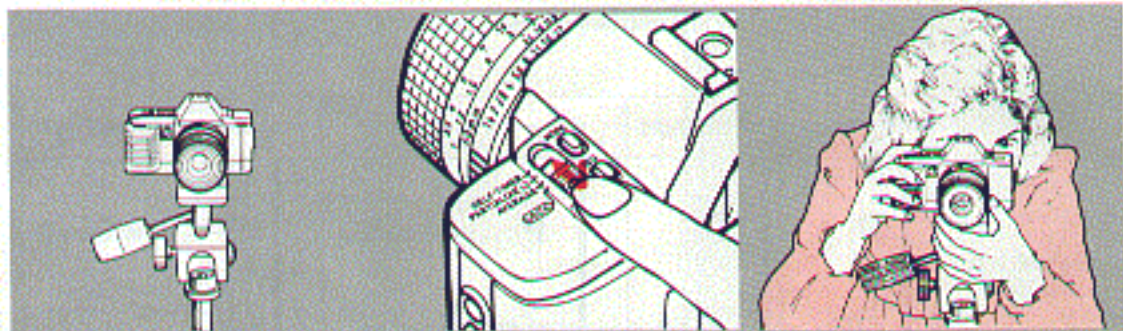

Use the self-timer when you want to be in the picture too.

1) Put the camera on a table, tripod, or other flat surface.

2) Set the main switch to SELF-TIMER.

3) Compose the picture and focus the subject.

4) Make sure the exposure is correct by checking the viewfinder information, then press the shutter button. A beeping sound will be emitted and the frame counter will display the countdown of seconds until shutter release.



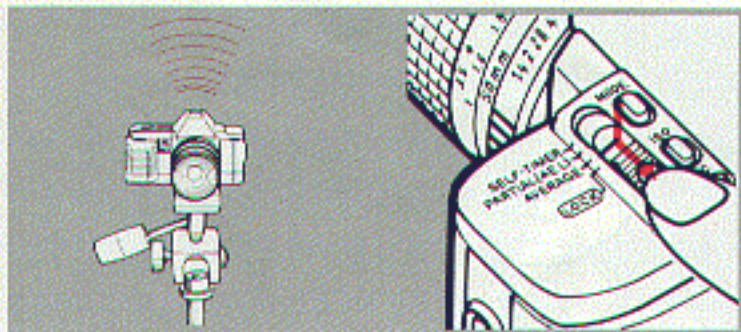

5) The shutter will be released automatically ten seconds after the shutter button is pressed. Two seconds before shutter release, the camera will begin beeping at a faster rate.

6) After release, reset the main switch to AVERAGE unless you want to use the self-timer for the next frame.

#### Notes

- For self-timer photography, the T70 sets the exposure (using center-weighted average metering) the moment you press the shutter button. Therefore, do not stand in front of the lens when you press the button or exposure may be incorrect.
- If you have started the self-timer and wish to cancel it before shutter release, press the battery check button "BC" or move the main switch off the SELF-TIMER position.

If your eye will not be at the viewfinder when you press the shutter button, cover the viewfinder as illustrated to avoid stray light from entering at the rear. Use the viewfinder cover attached to the neck strap shoulder pad for this purpose.

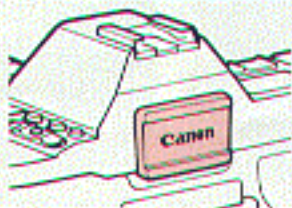

### 13. Dedicated Flash Photography with the Canon 277T

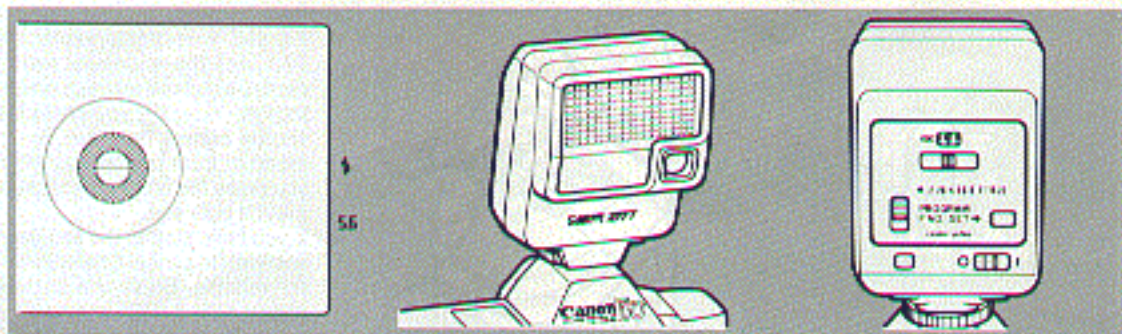

Switch to flash photography when the green 'P' in the viewfinder starts to blink. For best results, we recommend using the 277T with the T70. When using the 277T in the PROGRAM mode, flash photography is just as simple as general daylight photography.

Set the mode selector on the 277T to PROGRAM, turn on the flash's main switch, and wait until the pilot lamp lights. Then all you have to do is focus your subject and press the shutter button.

When you are ready to take a picture, press the shutter button. The flash will fire and the camera will take the picture. The flash will fire again if you press the shutter button again before the camera has finished taking the picture. This is called multiple flash photography. For more information on multiple flash photography, refer to page 54.

- The Canon Speedlite 277T can be used as a fill-in flash for daylight photography.
- For more information concerning flash photography, refer to page 54.





## 14. Rewinding the Film

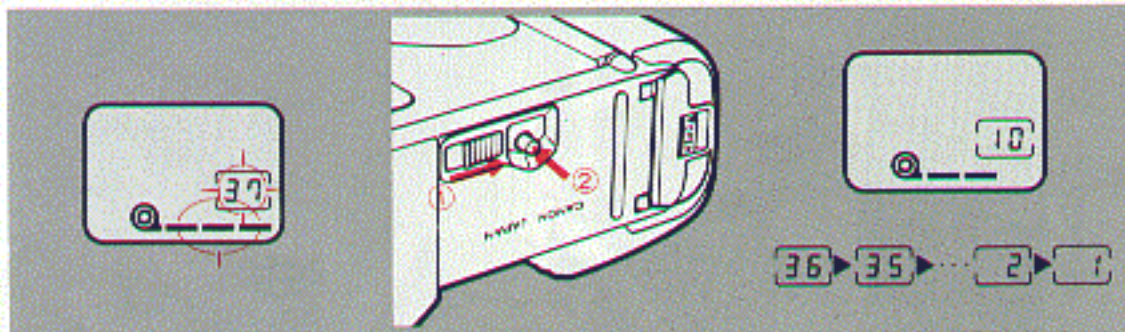

At the end of the film roll, film advance will stop automatically and the camera will beep for about four seconds to inform you that the end of the film has been reached. The frame counter number and the film transport indicator will blink on the display panel at this time.

1) While sliding the rewind button unlock switch in the direction of the arrow ①, press the rewind button until it locks ②.

2) The camera will rewind the film automatically and the frame counter will count down. At this time the three bars will move in sequence from right to left towards the cartridge display symbol.

The camera winds one frame after the end of automatic film rewind.



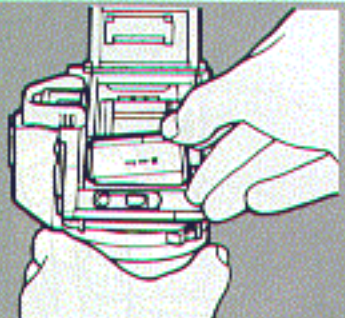
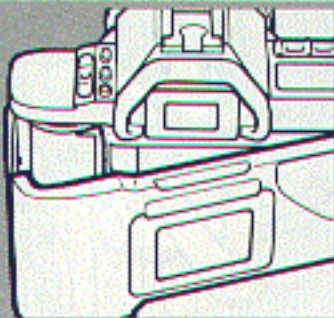

3) Film rewind stops automatically when the roll is completely rewound.

4) Open the back cover when the film-load check mark starts blinking.

5) Remove the film cartridge.

Do not open the back cover until the film-load mark on the display panel blinks.

There is an extremely rare possibility that, when the film advance stops at the end of the film roll, the mirror inside the camera body may not flip back to its normal position. If this happens, press the film rewind button while sliding the film rewind button unlock switch. The mirror will then return to its normal position.

## 15. Carrying the Camera

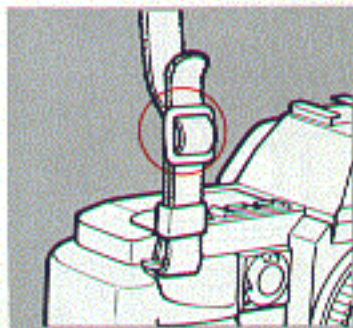

Thread the ends of the strap through the rings on the camera as shown.

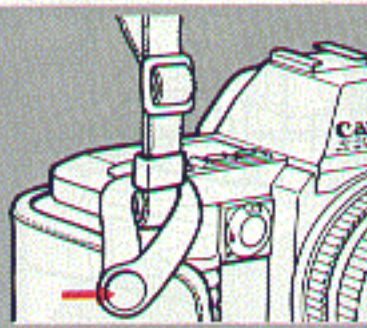

To protect the camera while carrying, insert it into its case as shown.



Unsnap the top cover of the case to remove it.



## 16. Pre-shooting Checklist

Is the lens aperture ring set to "A"?

Is the ISO set correctly?

Are the batteries loaded correctly and is their voltage sufficient?

Does PROGRAM (standard program) appear on the display panel?

ISO 100/21°

100 ISO

PROGRAM





# MAKING THE MOST OF YOUR T70

1. Batteries .....	30
2. Display Panel and Viewfinder Information .....	32
3. Focusing .....	34
4. Changing the Metering Area .....	35
5. Selecting an AE Mode .....	40
6. Exposure Warnings .....	44
7. Manual Mode .....	48
8. Stopped-down AE Mode .....	50
9. Shooting with Close-up Accessories .....	52
10. Flash Photography .....	54
11. Specialized Procedures .....	55
12. Basic Photography .....	56
13. Accessories .....	64
14. Caring for Your Camera .....	66
Specifications .....	71



## 1. Batteries

This camera will not operate without batteries. Try to make a habit of checking the batteries at the following times.

- After loading new batteries.
- After storing the camera for a long time.
- If the shutter does not release.
- When you are using the camera in low temperatures.
- Before shooting important events.

Even if one blinking bar mark or no bar mark appears on the display panel while checking the batteries, exposure will be correct as long as the shutter releases.

Use a new set of batteries as specified below or equivalent batteries of another brand.

- Two AA size 1.5 V alkaline batteries LR6 (AM-3)
- Two AA size 1.5 V carbon-zinc batteries R6 (SUM-3)
- Two AA size 1.2 V NI-Cd batteries



## Notes

- Always use two new batteries of the same brand and replace them both at the same time.
- Wipe the battery terminals and the camera contacts with a clean, dry cloth before loading, to ensure proper contact.
- Remove the batteries if you do not expect to use the camera for about three weeks or longer.
- When shooting in temperatures below 0°C (32°F), keep your camera and spare batteries close to your body or in a pocket to keep them warm until you are ready to take a picture. You can also use a set of Ni-Cd batteries which function well in low temperatures.
- Refer to the manufacturer's instructions for recharging Ni-Cd batteries.
- Three bars (—) may not appear on the display panel during the battery check, even if using fully charged Ni-Cd batteries, because of their low nominal voltage.
- The battery naturally discharges even when not in use, so try to check the batteries regularly.

## Shooting Capacity

Battery Temperature	Alkaline (LR6/AM-3)	Carbon-zinc (R6/SUM-3)	Ni-Cd
Normal (20°C/66°F)	60 rolls 40 rolls	20 rolls 13 rolls	30 rolls 20 rolls
Low (-10°C/14°F)	7 rolls 4 rolls	1 roll —	15 rolls 10 rolls

The upper data is for 24-exp. film and the lower data is for 36-exp. film.

## 2. Display Panel and Viewfinder Information

The T70 uses a large liquid crystal display panel to indicate shooting information. The diagram below shows all the information at the same

time; however, the display never actually looks like this. Normally the panel displays only the information required at the time.

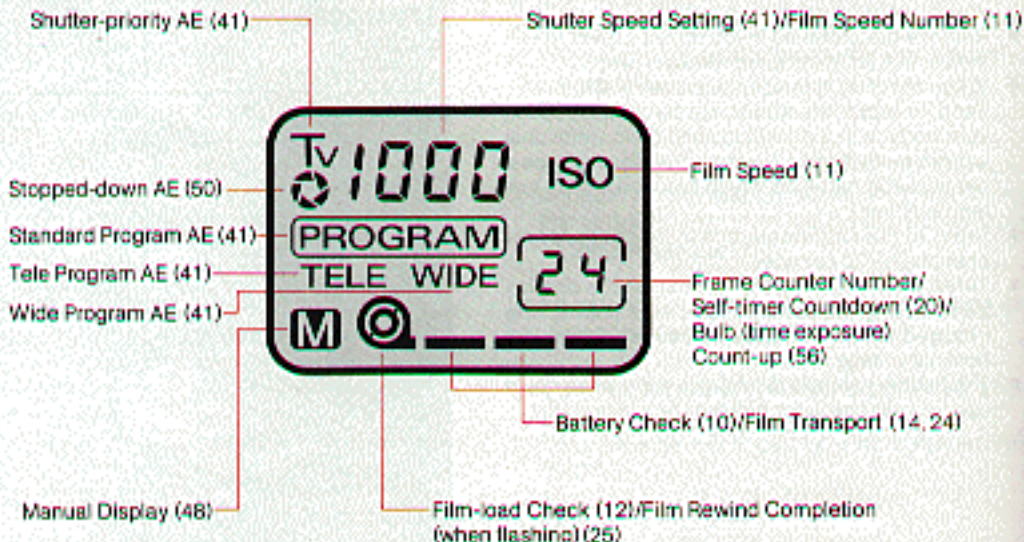

- Refer to the page in parentheses for further details on each LCD panel display item.



## Viewfinder Information

This viewfinder is bright and easy to read. Only the necessary information is displayed outside the field of view. The diagram below shows all the information at the same time for convenience.

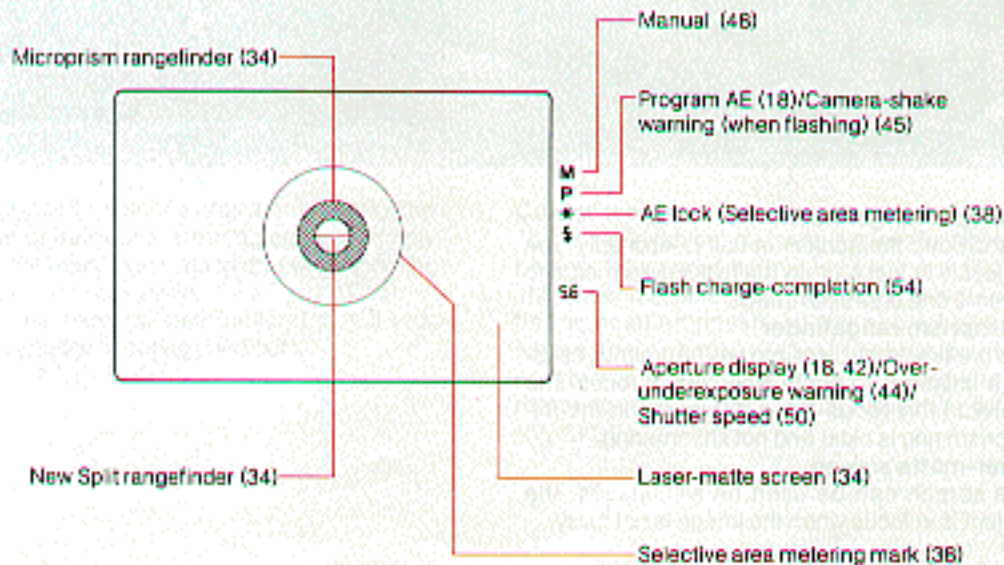

### 3. Focusing

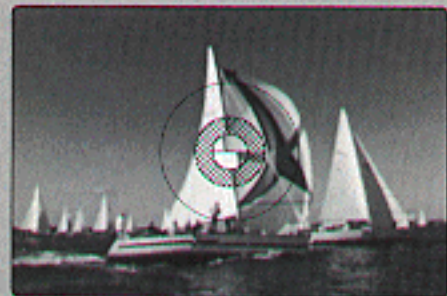

Out of focus

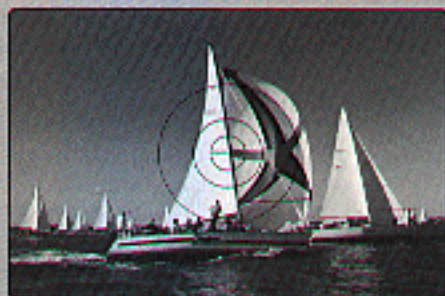

In focus

#### **New split rangefinder**

This divides the subject in half horizontally. The subject is in focus when the two halves merge to become one unbroken image.

#### **Microprism rangefinder**

This breaks the subject into tiny fragments, causing a shimmering effect when out of focus. The subject is in focus when the image in the microprism ring is clear and not shimmering.

#### **Laser-matte screen**

This screen can be used on all surfaces. The subject is in focus when the image is not fuzzy.



## 4. Changing the Metering Area

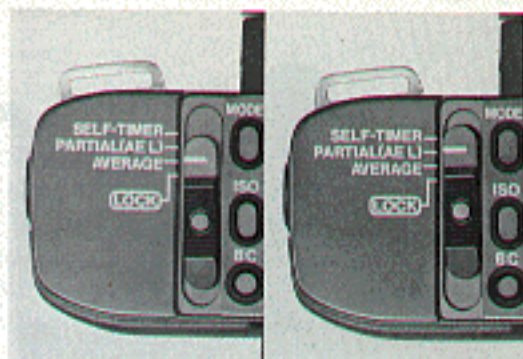

You can easily select either center-weighted average or selective area metering by simply moving the main switch, no matter what shooting mode the camera is set in.

Change the metering area (pattern) to suit your purpose and the shooting conditions.



### **Center-weighted average metering**

This is a convenient metering system for general photography under normal shooting conditions. The meter measures the entire viewing area, putting special emphasis on the central portion where the subject is most likely to be. The camera is in the center-weighted average metering mode when the main switch is set to **AVERAGE**.

## Selective area metering (AE Lock)

This system allows you to meter only the central portion of the image in the viewfinder, thus eliminating the influence of the brightness (or darkness) of the background. It is particularly effective for metering backlit subjects, such as a person in front of a bright window, or, conversely, a person with a dark background, such as in stage photography. With this metering system, the AE lock mechanism\* is held on as long as the shutter button is pressed halfway or the exposure preview button is pushed in.

- \* AE lock means that the same exposure value is kept locked in the camera's memory even when the picture is recomposed.

AVERAGE



Underexposure

AVERAGE



Overexposure



PARTIAL (AEL)



## Shooting with AE lock/selective area metering

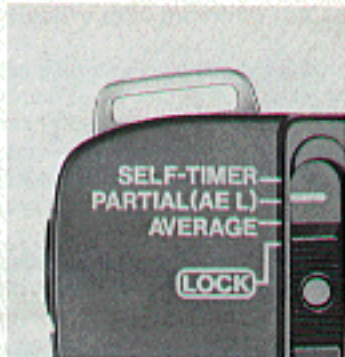

- 1) Set the main switch to "PARTIAL (AE L)".
- 2) Look in the viewfinder and focus the subject.

- 3) Put the main subject in the center of the viewfinder so that the selective area metering mark covers it (A).
- 4) Press the exposure preview button or press the shutter button halfway. A red asterisk (AE Lock LED) will appear in the viewfinder. If desired, while continuing to hold down the exposure preview button or the shutter button, recompose the picture so that the subject is not in the center (B).



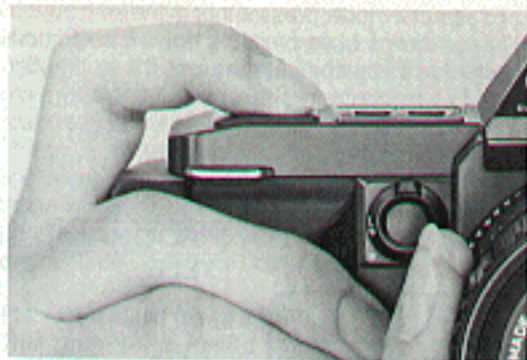

- 5) Make sure that no warning marks appear in the viewfinder and gently press the shutter button all the way down to take the picture.

### **Sequential AE lock photography**

When shooting continuously using the AE lock mechanism in the same lighting conditions (e.g. backlit subjects), it is not necessary to meter the subject for each shot as long as you do not remove your finger from the exposure preview button or the shutter button after each exposure.



### **AE lock and exposure compensation**

It is sometimes necessary to correct exposure when using a normal AE camera if there is a big difference in brightness between the main subject and the background (e.g. backlit or stage photography). The T70, however, has the above mentioned built-in AE lock mechanism which makes exposure compensation unnecessary. No matter what shooting mode the camera is in, if you set the main switch to "PARTIAL (AE L)" and use the camera as described above, no further exposure compensation is required.

## 5. Selecting an AE mode

You can select the following AE modes according to your purpose and the shooting conditions. (AE photography is possible only with FD lenses.)

- (1) **PROGRAM** : Standard program AE
- (2) **PROGRAM TELE** : Tele program AE
- (3) **PROGRAM WIDE** : Wide program AE
- (4) **Tv** : Shutter-priority AE with safety shift function

To select a mode, press either of the shift buttons (up or down) while pressing down the AE mode selector. If you continue to press the shift button, the four modes will appear in sequence.

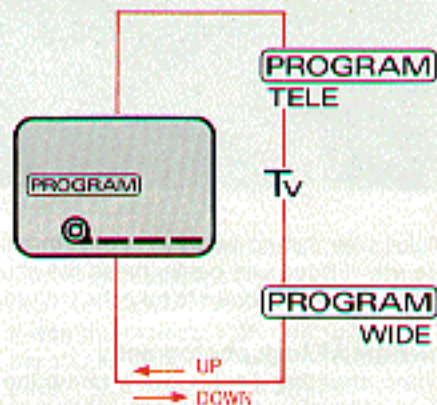



## ■ Program AE

Both aperture and shutter speed are automatically set by the camera according to the brightness of the subject and a programmed set of aperture/shutter speed combinations.

These programs are convenient for those who are taking pictures with an SLR for the first time, those who do not like to worry about complicated operation, or those who would simply like to concentrate on picture composition.

### (1) Standard program AE

This program is called standard because it is oriented toward neither shutter speed nor aperture size. It is the most popular programmed AE and is suitable for daily snap shots.

### (2) Tele program AE

Tele program's shutter speed/aperture combination is programmed so that the camera chooses the fastest possible shutter speed. It is effective for emphasizing the main subject by making the depth of field shallower. It is also well suited to stopping action in such areas as sports photography. When using a telephoto lens, which, because of its long focal length, is likely to cause blurred pictures due to camera-shake, this program's fast shutter speeds reduce the

possibility of blur.

### (3) Wide program AE

The wide program chooses the smallest possible aperture, thus allowing a deep depth of field. It is suitable for bringing not only the main subject but also the background and foreground into sharp focus and so is appropriate for landscapes or large group shots.

## ■ Shutter-priority AE

You set the shutter speed and the camera automatically chooses the correct aperture for the lighting conditions.

This mode is applicable to taking pictures of moving subjects. By controlling the shutter speed, you can also control the subject's movement. Faster shutter speeds can be used to freeze subject motion and slower shutter speeds can provide artistic blur effects.

## Shutter-priority safety shift function

If the selected shutter speed is too slow or too fast for the light conditions, the T70 automatically switches the shutter speed to a higher or lower one that will avoid under or overexposure.

### Notes

1. The shutter speed is automatically set to 1/125 sec. when switching to the shutter-priority AE mode from other modes.
2. You can lock the shutter speed by setting the shutter speed shift lock lever to the "L" position. Even if you press the shift buttons (up or down) accidentally, the shutter speed will not be changed.

If you would like to select the aperture:



- 1) First make sure the shutter speed shift lock lever is disengaged from "L".
- 2) Then, while pushing the exposure preview button, press the shift buttons until the desired f/stop appears in the viewfinder.

To choose a shutter speed, refer to the table below.

inside		cloudy		clear	
30	60	125	250	500	1000

Refer to page 58 for more information about exposure (shutter speed and aperture).



## Automatic exposure coupling range

When using an FD 50 mm f/1.4 lens and ISO 100 film, the built-in exposure meter couples within a range of EV1 (f/1.4 at 1 sec.) to EV19 (f/22 at 1/1000 sec.).

- Meter coupling range changes depending on the film speed.

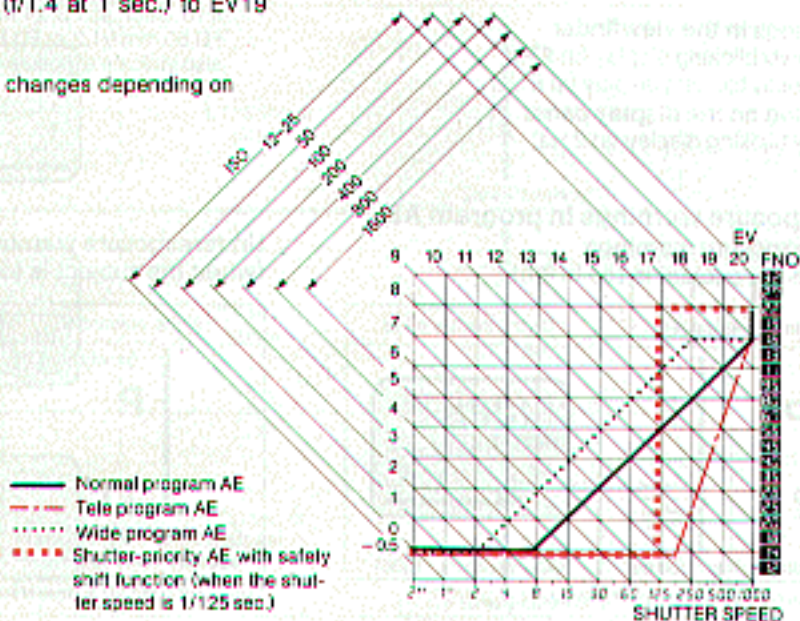

Meter coupling range in each AE mode is indicated as follows.



## 6. Exposure Warnings

Check the exposure by pressing the exposure preview button or by pressing the shutter button halfway.

### Warnings in the viewfinder

- 1) Slowly blinking display (at 2 Hz) 
- 2) Rapidly blinking display (at 8 Hz) 



### Warning on the display panel

- Slowly blinking display (at 2 Hz) 

### ■ Exposure warnings in program AE

#### Overexposure warnings

(when the subject is too bright)

In the viewfinder	On the display panel
 <p>Rapidly blinking f-number</p>	 <p>Slowly blinking "1000"</p>

(when using the FD 50 mm f/1.4 lens)

→ In this case, use an ND (neutral density) filter.

### Notes

- When using a lens with a minimum aperture of f/32, even if 1/27 blinks, exposure will be correct.
- When using a lens with a minimum aperture of f/16 (such as FD 24 mm f/1.4L, FD 50 mm f/1.2L, FD 50 mm f/1.2, or FD 85 mm f/1.2L), f/19 and 1/22 also indicate exposure warnings.

#### Underexposure warnings

(when the subject is too dark)

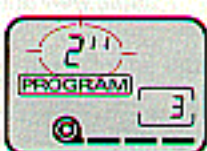





In the viewfinder	On the display panel
 <p>Slowly blinking "P"</p> <p>Rapidly blinking maximum aperture of the lens in use</p>	 <p>Slowly blinking "2"</p>

(when using the FD 50 mm f/1.4 lens)

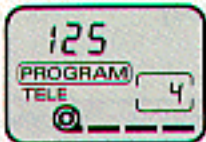
→ In this case, use a Canon Speedlite.

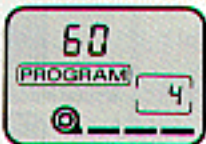

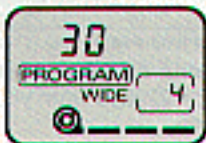
**Camera-shake warnings (when the shutter speed is too slow to hand-hold the camera).**

Program AE mode	Shutter Speed	Warning in the Viewfinder
<p>Tele</p> 	<p>1/125 sec. or slower</p>	 <p>Slowly blinking "P"</p>
<p>Standard</p> 	<p>1/60 sec. or slower</p>	 <p>Slowly blinking "P"</p>
<p>Wide</p> 	<p>1/30 sec. or slower</p>	 <p>Slowly blinking "P"</p>

(When using the FD 50 mm f/1.4 lens)

— In these cases, use a Canon Speedlite or fix the camera on a tripod.

## ■ Exposure warnings in shutter-priority AE mode

### Overexposure warnings

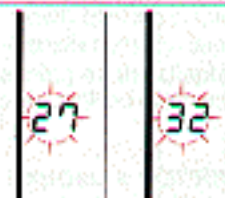
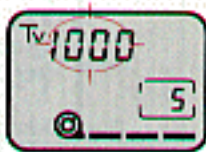
In the viewfinder	On the display panel
 <p>Rapidly blinking 1/stop</p>	 <p>Slowly blinking "1000"</p>

(when using the FD 50mm f/1.4 lens)

— In this case, use an ND (neutral density) filter.

### Shutter speed safety shift function warnings

(1) When "22" is blinking slowly (at 2 Hz) in the viewfinder, it indicates that the safety shift is functioning and that the preset shutter speed will be switched to a faster speed.

The original shutter speed is displayed on the display panel.

The new shutter speed will be displayed on the LCD panel when the exposure preview button is pressed or when the shutter button is pressed halfway.

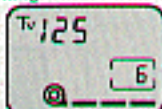
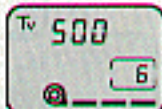
In the viewfinder	On the display panel
 <p>"22" is blinking</p>	<p>Initial setting</p>  <p>Shifted shutter speed ▼</p> 

(when using the FD 50mm f/1.4 lens)

- When using a lens whose smallest f/number is f/16; f/19 and f/22 also warn you of overexposure.

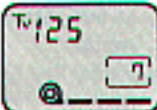
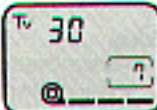

(2) When the maximum aperture is blinking slowly (at 2 Hz), it indicates that the safety shift is functioning and that the preset shutter speed will be switched to a slower speed. The preset shutter speed is displayed on the display panel.

In the viewfinder	On the display panel
 <p>The smallest f-number of the lens in use is blinking</p>	<p>Initial setting</p>  <p>Shifted shutter speed ▼</p> 

(when using the FD 50mm f/1.4 lens)

## Underexposure warnings

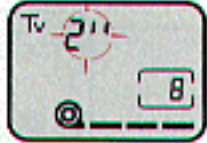
In the viewfinder	On the display panel
 <p>Rapidly blinking of the maximum aperture of the lens in use</p>	 <p>Slowly blinking 2*</p>

(when using the FD 50mm f/1.4 lens)

→ In this case, use a Canon Speedlite.

## 7. Manual Mode

This is a creative mode in which you can control both the shutter speed and the aperture size.

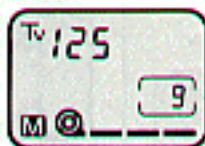

- 1) Press either of the shift buttons (up or down), while pressing the AE mode selector, until "Tv" appears on the display panel.
- 2) Remove the aperture ring from the "A" setting. An "M" will then be displayed on the display panel.
- 3) Set the desired shutter speed by pressing the shift buttons.
- 4) While looking in the viewfinder, press the exposure preview button or the shutter button halfway. The "M" will blink (at 4 Hz) to indicate that the camera is in the manual mode.
- 5) Read the f/stop displayed in the viewfinder and set the aperture ring of the lens to that aperture.

### Notes

1. Manual override is not possible if the camera is set in one of the program AE modes.
2. The shutter speed safety shift will not function in the manual mode.
3. Exposure compensation is also possible if in step 5) above, a different aperture from the one displayed in the viewfinder is set on the lens.

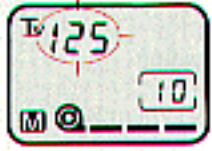

## Overexposure warnings

In the viewfinder	On the display panel
	
Rapidly blinking f/stop	Slowly blinking shutter speed

(when using the FD 50 mm 1/1.4 lens)

- Set a faster shutter speed until the f-number stops blinking.

## Underexposure warnings

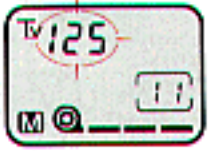
In the viewfinder	On the display panel
	
Rapidly blinking maximum aperture of the lens in use	Slowly blinking shutter speed

(when using the FD 50 mm 1/1.4 lens)

- Set a slower shutter speed until the maximum aperture stops blinking.

## 8. Stopped-down AE Mode

It is necessary to use the stopped-down mode when using close-up accessories which have no FD signal pins, such as extension tubes, bellows FL, the Canon reflex lens or FL lenses.

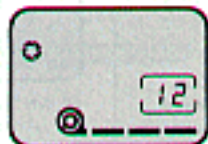

- 1) While pressing the AE mode selector, press the shift button until the  appears on the display panel.
- 2) Compose the picture and focus the subject.
- 3) Set the desired aperture on the aperture ring.
- 4) Check the exposure and press the shutter button.

The numbers in the viewfinder represent the shutter speed. "H.L." indicates either 1/125 sec., 1/180 sec., 1/250 sec., or 1/350 sec., and "H.H." indicates 1/500 sec., 1/750 sec. or 1/1000 sec.

It is not possible to set the camera in the stopped-down AE mode when an FD lens is mounted directly on the T70.

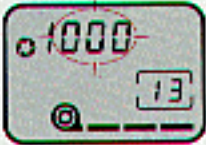

## Overexposure warnings

In the viewfinder	On the display panel
	
Rapidly blinking "H.H."	Slowly blinking "1000"

→ Choose a smaller aperture until the "H.H." stops blinking.

## Underexposure warnings

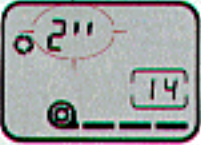
In the viewfinder	On the display panel
	
Rapidly blinking "2'' (2 sec.)"	Slowly blinking "2''"

→ Turn the aperture ring to choose a larger aperture until the "2''" stops blinking.

## 9. Shooting with Close-up Accessories

### Manual Diaphragm Control



Stopped-down metering is necessary whenever you insert accessories, such as Extension tubes M, between the camera and the FD lens for close-up photography.

- 1) Insert the slot of the accessory manual diaphragm adapter (optionally available) over the tip of the automatic aperture lever at the rear of the lens.
- 2) Push the lever counterclockwise and lower the adapter into the groove.
- 3) Mount the lens as it is on the accessory.

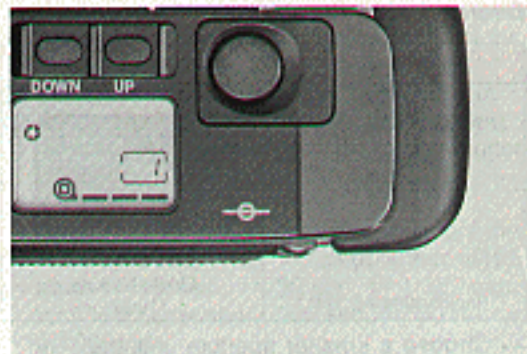

### Film plane indicator

This mark, engraved on the top of the camera body, indicates the exact position of the film plane. It is useful for measuring the exact shooting distance from film to subject in close-up photography. Distances on the lens' distance scale are calibrated from this mark.

Do not mount the lens with manual diaphragm adapter directly on the camera or the Auto Bellows etc.





Lenses which cannot be mounted on the T70:

FL 19 mm f/3.5 FL 58 mm f/1.2

Lenses which cannot be used with the T70's meter for mechanical reasons:

FL 19 mm f/3.5 Retro-focus

FL 50 mm f/1.8 FL 35 mm f/2.5

(Use of an independent exposure meter is recommended)

## PRECAUTION

Exposure compensation is necessary, according to the lens, when using the Canon Extender 2X. Correct the exposure by changing the ISO film speed as follows.

**A type** . . . . Set the film speed 1/3 step higher.

**B type** . . . . (1) With lenses having a maximum aperture of f/1.2 to f/1.8; set the film speed 2/3 step lower.

(2) With lenses having a maximum aperture of f/2; set the film speed 1/3 step higher.

(3) With other lenses: no correction is required.

## 10. Flash Photography

Flash	Canon Speedlites			Other makers' flashes
	277T	244T	Speedlites such as 188A, 533G, 577G	
Shutter Speed	Switches automatically to 1/60 sec.			Manually set to 1/60 sec.
Aperture	<ul style="list-style-type: none"><li>• In PROGRAM AE: T70 automatically selects an f/stop from f/2 to f/22</li><li>• In F. NO. SET mode: an f/stop chosen from among 6 f/stops (f/2 to f/22) is manually set on the Speedlite</li></ul>	T70 automatically selects f/stop: either f/2.8, f/4 or f/5.6	Auto-flash f/stop manually set on the Speedlite	Auto-flash f/stop manually set on the flash and the lens or the one calculated by the guide number formula manually set on the lens

- With a Canon Speedlite, a  mark will light up in the viewfinder when the flash is charged.

### Notes

1. It is recommended that a Canon flash unit be used with this camera. Using a flash (usually with more than two contacts) or flash accessory of another maker may cause the camera to work improperly or even possibly damage the camera itself.
2. For further details, consult the speedlite's instructions.



## 11. Specialized Procedures

### ■ Shooting with Infrared Film



When you load the T70 with black and white infrared film, it is necessary to make a slight adjustment in focus. A red infrared index is engraved on most Canon lenses for this purpose.

- 1) Focus as usual looking through the viewfinder.
- 2) If, for example, the lens is focused at 10m on the distance scale, turn the focusing ring to align the 10m mark with the red dot.
- 3) Release the shutter after making this correction.

#### Notes

1. When using infrared film, it is necessary to use a deep red filter, as specified by the film manufacturer.
2. The position of the infrared index mark has been computed for the use of infrared film with peak sensitivity at 800 nm.
3. When using color infrared film, read the instructions of the film manufacturer.

## ■ Long exposure (bulb) shooting

It is possible to make an exposure longer than 2 seconds when doing such types of photography as astro or night photography.

- 1) Set the camera to the shutter-priority AE mode.
- 2) Press the down shift button to select "bulb".
- 3) Manually set an aperture.
- 4) The shutter will remain open as long as you press the shutter button.

### Notes

1. Bulb operation time is displayed on the display panel by a series of 3 bars and the numbers 1—30. Each bar mark (—) indicates 30 seconds. Exposure time up to 120 seconds is possible (3 bars plus 30).
2. It is possible to control the exposure time within a range of 23 hours 59 minutes 59 seconds by using the Command Back 70 (optionally available).
3. Use of a tripod and cable release is recommended when making long exposures (see pages 65 and 66).

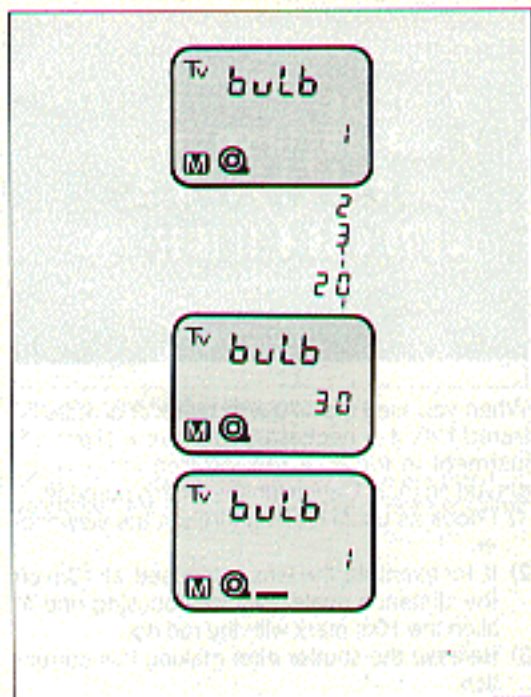

The Canon T70 is designed so that bulb exposure requires relatively little power, thus saving energy.





The Canon T70 is an SLR camera designed so that picture taking is easy even for those who do not know a lot about shutter speed, aperture and exposure. Reading the following instructions, however, will help make your pictures more creative.

### (1) Exposure

Taking a picture is a matter of controlling the amount of light allowed to fall on the film. This is called exposure. When you press the shutter button, some blades inside the lens, called a diaphragm, close down to form an opening, called the aperture.

Almost simultaneously, the first shutter curtain starts to move inside the camera. A second shutter curtain follows it after a fixed interval which you can control on the display panel. The amount of light that exposes a frame depends on the shutter speed and the size of the aperture. For the same exposure, a change in the shutter speed requires an equal and opposite change in the aperture. When in the shutter-priority AE mode, the T70 automatically makes this change in aperture when you change the shutter speed. In programmed AE, the camera automatically chooses a combination of shutter speed and aperture for correct exposure. There are usually several combinations of shutter speed and aperture which will give the same exposure and this is the key to creative photography.





[Example Shown: FD 50 mm f/1.4 lens. Maximum and minimum apertures differ depending on lens.]

## (2) Shutter speed and aperture

Numbers such as 125, 250 on the display panel represent shutter speeds of 1/125 sec. or 1/250 sec., while numbers like 1.4, 2.8, 4, etc. on the lens aperture ring or in the viewfinder represent apertures, which are usually called f-numbers or f/stops.

Each time you move from one f/stop to the next smaller f/stop (larger number), the amount of light is exactly halved. As you move from one shutter speed to the next higher speed, exposure is also halved.

1/1000 sec.	1/500	1/250	1/125	1/50	1/30	1/15
f/1.4	f/2	f/2.8	f/4	f/5.6	f/8	f/11

If, for example, the combination of f/4 and 1/125 sec. will yield correct exposure, there are certain other combinations of aperture and shutter speed which will give you the same amount of exposure value (EV). (eg. f/2.8 and 1/250 sec. or f/5.6 and 1/60 sec.)

### (3) How to choose a shutter speed

The basic function of shutter speed is to get correct exposure, but you can also use it to control the expression of your subject's motion and to control the effect of camera movement.

Your pictures will not be sharp if the camera moves when you press the shutter button. This is referred to as "camera-shake". Generally, for handheld shooting, do not select a shutter speed which is smaller than the focal length of the lens. For handheld shooting with a 50 mm lens, for instance, set a shutter speed of 1/60 second or faster; with a 100 mm lens, at least 1/125 second or faster. If this is not possible, use a tripod and cable release to avoid camera-shake.

- With a wide-angle (less than 50 mm) lens, it may be possible to use shutter speeds slightly slower than 1/60 second for handheld shooting.

When using the T70 in the programmed AE modes, the camera-shake warning is a slowly blinking "P" (blinks at 2 Hz).



1/1000 sec

#### A. Freezing Motion

Usually shutter speed is chosen to freeze the subject motion. The faster the subject is moving, the higher the shutter speed required to stop the action.





1/15 sec.

### B. Blurring the Subject's Motion

Blurring part of the picture intentionally can give a convincing sense of action. To blur the subject, simply set a shutter speed which is too slow to freeze its action.



1/30 sec.

### C. Panning

You can also blur the background by "panning". Choose a shutter speed suitable for the subject's motion and release the shutter as you follow the movement, turning the upper part of your body.

#### (4) How the Aperture Affects the Picture



A. The smaller the aperture, the wider the range of sharpness, or depth of field. This is illustrated by the picture above which was taken at  $f/16$ . Compare it with the photo to its right. This deep depth of field is especially good for such subjects as landscapes.



B. The larger the aperture, the narrower the range of sharpness. An aperture of  $f/1.4$ , for instance, can isolate your subject from its surroundings. This technique is often used to blur a disturbing background in portraiture.

When the lens is mounted on the camera, the aperture is completely open in order to keep the viewfinder bright (full-aperture metering). The aperture closes down to the value displayed in the viewfinder when you release the shutter.



## (5) Depth of Field

When your subject is in focus, there is a certain area in front of it and behind it which will also be in focus. This range of sharpness is called depth of field. Depth of field is greater the shorter the focal length of the lens. For example, a 24 mm lens will provide greater depth of field than a 50 mm lens, provided the aperture and shooting distance are the same. Depth of field is also greater the longer the shooting distance and is generally greater in the background than in the foreground by a ratio of two to one.

### To check the depth of field:

- 1) First focus. Then press the shutter button half-way and read the aperture number which appears in the viewfinder. Find the two aperture numbers on the depth-of-field scale on the lens which correspond to that number.
- 2) Draw imaginary lines from those two numbers to the distance scale. The effective depth of field lies between those two distances. For example, using a standard 50 mm lens focused at 3 m with the aperture set at  $f/8$ , depth of field extends from 2.4 m to 4.5 m. Any subject from 2.4 m to 4.5 m away will be in reasonably sharp focus.



## 13. Accessories

### Canon Command Back 70

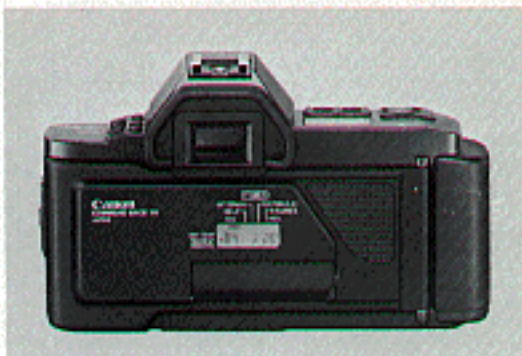

The Command Back 70 is an interchangeable camera back designed for exclusive use with the T70. As the name "Command" suggests, it not only records data but also controls the T70 for various types of timed photography. The following operations are possible using the quartz controlled Command Back 70:

#### DATA FUNCTION

1. Printing of the auto date up through the year 2029 (automatic compensation for leap years and long and short months).
2. Printing of the Day/Hour/Minute in a 24 hour format.

3. Printing of an arbitrary 6-digit number plus the letters A through F.
4. Printing of a frame counter number up to 4 digits.

#### TIMER FUNCTION

1. Self-timer (the shutter is released after a fixed period of time).
  2. Interval timer (the shutter is released at fixed intervals.)
  3. Long release timer (the shutter is released and held open for a fixed period of time when the T70 is set to "buLb").
  4. Frame counter setting (the camera stops automatically after the set number of exposures has been made).
- The timer settings can be set to any value from one second to 23 hours, 59 minutes, 59 seconds.
  - It is possible to use both the data and timer functions at the same time.
  - It is possible to program the camera completely by combining modes 1—4 in the timer function.



## Speedlite 277T, 299T



The 277T can be used as a fill-in flash for outdoor shooting as well as a normal flash when shooting at night or in a dimly lit room. For example, when you use the 277T to take a picture of a person backlit by the sun, your subject will not be too dark and the background will not be overexposed. 8 f/stops can be selected from  $f/2$  to  $f/22$  allowing you to consider the depth of field even in flash photography.

The 299T offers many impressive features, such as two MANUAL modes, a built-in zoom mechanism and a bounce flash mechanism, to help overcome various difficult subject lighting conditions.

## Remote Switch 60T3



The Remote Switch 60T3 is designed to be used when the camera is mounted on a tripod for close-up shooting or when using a telephoto lens with which camera-shake is a particular problem. Attach directly to the camera's remote control socket.

## Wireless Controller LC-1



This accessory is a remote control photography device which uses infrared rays to control the camera from a distance. The LC-1 is particularly useful in such areas as sports photography, wildlife photography, and news coverage. The Wireless Controller LC-1 consists of a transmitter and a receiver. Use of the **Remote Switch Adapter T3** is also required. Up to three cameras can be operated in series when the receivers are set to different channels.

## Close-up/Macrophotography Accessories

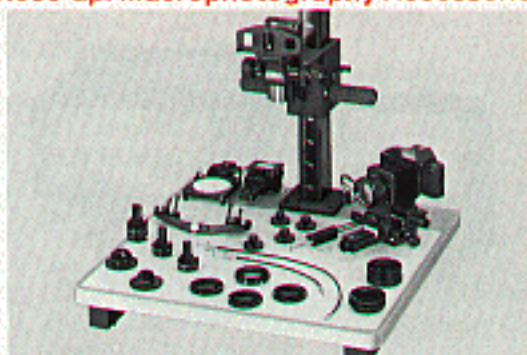

Accessories such as the Auto bellows, Copy stand 5 and Macrolite ML-1 are designed for everything from simple close-up photography to life-size and magnified macrophotography.

### Cable Release Adapter T3

This is an accessory for use with the Double Cable Release when using the Auto Bellows. It is possible to use this adapter with the Release 30 or 50.



## Lens Hood



We strongly recommend the use of a lens hood to keep out side light which may cause flare and ghost images to form on the image. Rigid Canon hoods also help to protect the lens from shock. Use only a hood which is specified for your particular lens. Most Canon hoods fit into the bayonet mount and are fixed by turning. For more details, please see the lens instruction manual.

## Dioptric Adjustment Lenses S

Ten eyesight correction lenses are available in powers of +3, +2, +1.5, +1, +0.5, 0, -0.5, -2, -3 and -4 diopters. They may make viewing and focusing easier if you are near or farsighted. Slide the Eyecup T up to remove it before you attach the dioptric adjustment lens to the camera. Choose the one which is closest to your eyeglass prescription, and make a practical test if possible.

Attaching the dioptric adjustment lens with the Eyecup T is not possible.

## 14. Caring for your camera

As with any precision instrument, proper care and maintenance involve a few simple rules in addition to common sense. Observing these few rules will keep your T70 in top condition at all times.

We recommend that you clean your T70 periodically using the tools listed below.

**Cleaning tools:** Blower brush, Cleaning fluid, Cleaning tissue, Silicone cloth.

**(1) To clean the lens surface and the viewfinder:**

Blow off dust with the blower brush and then gently wipe the lens surface with a lens cleaning tissue which has been moistened with a few drops of lens cleaner.

**(2) To clean the reflecting mirror and the focusing screen:**

Use only a blower brush. If more cleaning is necessary, NEVER attempt to do it yourself but take it to an authorized Canon service facility.

**(3) To clean the film chamber:**

The film compartment also requires occasional cleaning with a blower brush to remove accumulated film dust particles which might scratch the film.

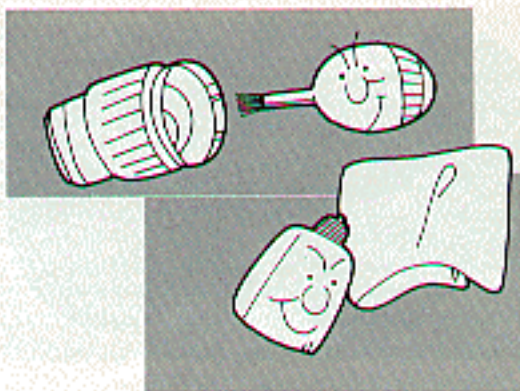

**(4) To clean the film pressure plate and the film guide rails:**

Lightly wipe the surface with a cleaning tissue moistened with cleaning fluid.



## PRECAUTIONS

- Be careful **NEVER** to touch the shutter curtain.
- After using the camera on a beach, clean it thoroughly. Salt and sand are your T70's worst enemies.
- Aerosol spray dust removers are not recommended for the shutter curtain area. If used, hold the can at least 20 cm (8 inches) away from the curtain.
- Film passing through X-ray examinations at airports, even when loaded in a camera, may be exposed and ruined. To avoid accidental exposure, tell the inspector you want your camera and film hand checked.

## Storage of your T70

The best thing you can do for your T70 is to use it regularly. In the event that you must store it for quite a while, however, first remove it from its case or camera bag. Remove the batteries. Wrap the camera in a clean, soft cloth and place it in a cool, dry, dust-free place. If you store the body and lens separately, attach both the body and rear lens caps.

### Avoid storing your T70 in the following places:

- "Hot Spots" such as the trunk, rear window shelf or glove compartment of a car.
- Laboratories or other such areas where chemicals may cause corrosion.
- In direct sunlight.

Before using the T70 after it has been stored for a long time or before using the camera for important events, carefully check the operation of each part.

## Liquid Crystal Display

The T70's display panel uses liquid crystal to indicate exposure information. After about 5 years of normal use, the display may become hard to read.

The liquid crystal may respond relatively slowly in low temperatures and the display may become dark at high temperatures (about 60°C/140°F). Normal functioning will return when the temperature returns to normal.

## Back-up battery

The T70 has a built-in back-up battery which memorizes the display panel data, such as the frame counter number and the ISO film speed, when the AA size batteries are taken out for replacement. Battery life is about 5 years. When voltage becomes insufficient, "ISO 100" will blink (at 2 Hz) on the display panel after loading batteries for normal camera operations. If the back-up battery is removed, the memory will be erased. In this case, reset the film speed.

Take your camera to the nearest Canon Service facility for the replacement of the liquid crystal or the back-up battery. (Replacement will be at the owner's expense.)



## Specifications

**Type:** 35 mm single lens reflex (SLR) camera with electronically controlled automatic exposure (AE) and focal-plane shutter. Wind/rewind fully automatic.

**Format:** 24 x 36 mm

**Exposure modes:** Multi-program AE (Standard program, Tele program, Wide program), shutter-priority AE with safety shift function, manual, stopped-down AE (only for lenses without AE signal pins.), program flash AE and electronic flash AE (with Canon Speedlite 277T).

**Usable lenses:** Canon FD lenses (full aperture metering) and non-FD lenses (stopped-down metering).

**Viewfinder:** Fixed eye-level pentaprism without condenser. Gives 92% vertical and horizontal coverage of actual picture area and 0.85x magnification at infinity with a standard 50 mm lens.

**Finder information:** Displayed to the right of viewing area.

4 point LED: P lights up steadily when camera is in the program mode and exposure is correct. Flashes at 2 Hz to give camera-shake warning. \* lights to indicate AE lock. \$ lights when the flash is fully charged. M flashes at 4 Hz to indicate manual setting.

2 digital display: Indicates aperture setting in shutter-priority AE and program AE. Indicates shutter speed setting in stopped-down AE. (High shutter speeds are abbreviated so that 1/125-1/350 sec become HL, and 1/500-1/1000 sec become HH. Display flashes at 8 Hz to indicate over and underexposure. Display flashes at 2 Hz when safety shift function is operating during shutter-priority AE. Selective area metering range mark. (In center of screen)

**Dioptic adjustment:** Built-in eyepiece is adjusted to standard -1 diopter.

**Mirror:** Quick return type with shock and noise absorber.

**Eyepiece cap:** Stored in the shoulder pad of the neckstrap.

**Light metering system:** Through-the-lens (TTL) full aperture metering (for FD lenses), using silicon photocell (SPC). Two selectable weighting patterns, center-weighted average metering and selective area metering. (Selective area metering can only be used with AE lock.) (When using lenses or accessories without AE signal pins, only stopped-down metering may be used.)

**Meter coupling range:** With ISO 100 film and a 50 mm f/1.4 lens: EV 1-19.

**Film speed:** ISO 12-ISO1600, (in 1/3 steps). Displayed on the LCD panel when pressing the ISO button.

**Exposure reading:** Exposure can be checked by pressing exposure preview button, or by pressing shutter button halfway.

**Shutter:** Vertical travel electromagnetic attraction focal-plane shutter (EMAS).

**Shutter speeds:** Automatic: 1/1000 sec-2 sec. Manual: 12 settings, 1/1000, 1/500, 1/250, 1/125, 1/60, 1/30, 1/15, 1/8, 1/4, 1/2, 1, 2 sec and Bulb. (X-sync = 1/90 sec.)

**Self-timer:** Electronically controlled, with a delay of approx. 10 sec.

**Camera-shake warning:** The P mark in the finder flashes at 2 Hz during program AE mode operations for the following shutter speeds: Standard program: 1/60 sec or slower. Tele program: 1/125 sec or slower. Wide program: 1/30 sec or slower.

**Film loading and first frame positioning:** Automatic. After the film has been positioned and the back cover closed, the film is automatically advanced to the 1st usable frame and then automatically stopped. Three blank frames are advanced. The frame counter display then reads "1".

**Film wind:** Automatic using built-in motor, enabling continuous shooting. Confirmation by floating bar marks on LCD panel. When the end of the film is reached, the film-load indicator and the frame counter number on the LCD panel start blinking. A beeping sound is also emitted.

**Film rewind:** Automatic using built-in motor. Automatic stop after film has been rewound into the cartridge. Rewind completion is indicated on LCD panel.

**Frame counter:** Shown on the LCD panel. Additive type with numbers 1-39, counts down during film rewind.

**Back cover:** Removable, with memo holder. Opened by sliding latch with safety lock.

**Flash contact:** Coupled directly to the camera by means of the X-contact on the accessory shoe.

**Automatic flash:** Program flash AE: With the Speedlite 277T. After sending out an infrared pre-flash to judge the distance and the reflectivity of the subject, the 277T sets the aperture and 1/90 sec shutter speed automatically. When out of shooting distance range (too far away), a warning is given, indicated by the aperture value flashing in the viewfinder.

Electronic flash AE: With the 277T in "F.NO. SET" mode, or with other Canon Speedlites.



shutter speed is set automatically to X-sync and aperture to the f/stop that has been set on the flash.

**Power source:** Main power source: Two AA size (3V) batteries. Alkaline batteries are standard but carbon-zinc and Ni-Cd batteries may also be used. Memory back-up: Built-in lithium battery (BR-1225 or CR-1220), battery life is approx. 5 years.

**Power switch:** The power is turned OFF by setting the main switch to "LOCK."

**Battery check:** By pressing the battery check (BC) button. Three energy levels are shown by bar marks on the LCD.

**Remote control:** Possible. With three-terminal contact for remote control. Remote Switch 60 T3 is required.

**Dimensions:** 151 (W) × 89.2 (H) × 48.4 (D) mm (5-15/16" × 3-1/2" × 1-7/8")

**Weight:** 530 g (18-11/16 oz) body only.

Subject to change without notice.



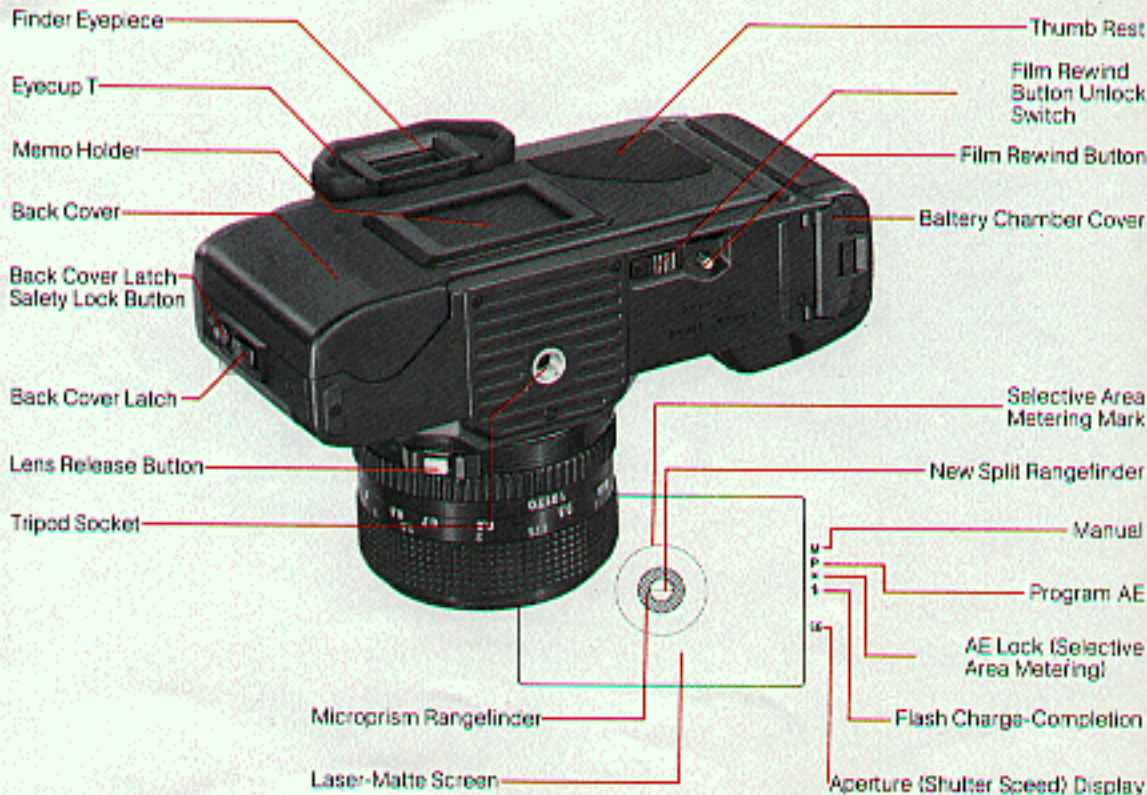





# Canon

**CANON INC.**  
1-1, Honcho Building 2-Chome, Bunkyo-ku, Tokyo 113, Japan  
Mailing address: P.O. Box 1005, Canon House Building, Tokyo 100, Japan

- U.S.A.**  
**CANON U.S.A., INC. HEADQUARTERS**  
One Canon Plaza, Lake Success, N.Y. 11042, U.S.A.  
**CANON U.S.A., INC. MANHATTAN SERVICE CENTER**  
400 Third Avenue, New York, N.Y. 10016, U.S.A.  
**CANON U.S.A., INC. ATLANTA BRANCH**  
6000 Peachtree-Dunwoody Road, Roswell, Georgia 30075, U.S.A.  
**CANON U.S.A., INC. CHICAGO BRANCH**  
100 Indiana Center, Evanston, Illinois 60120, U.S.A.  
**CANON U.S.A., INC. LOS ANGELES BRANCH**  
124 Pasadena, Pasadena East, California 91104, U.S.A.  
**CANON U.S.A., INC. LOS ANGELES SERVICE CENTER**  
8001 Wilshire Blvd., Los Angeles, California 90048, U.S.A.  
**CANON U.S.A., INC. SANTA CLARA BRANCH**  
16000 Saratoga Road, Santa Clara, California 95051, U.S.A.  
**CANON U.S.A., INC. DALLAS OFFICE**  
2008, Topp Lane, Suite 120, Dallas, Texas 75229, U.S.A.  
**CANON U.S.A., INC. HOUSTON OFFICE**  
Box 5-0, 7500, Arroyo Blvd., Houston, Texas 77055, U.S.A.
- CANADA**  
**CANON CANADA INC. HEADQUARTERS**  
Eaton Court Place, Scarborough, Ontario M1V 1Y7, Canada  
**CANON CANADA INC. MONTREAL SERVICE CENTER**  
1981 12th Avenue, Lachine, Quebec H8R 1A6, Canada  
**CANON CANADA INC. CALGARY OFFICE**  
1937, 15th Street NE, Calgary, Alberta T2E 2V2, Canada
- EUROPE**  
**CANON EUROPA S.A.**  
P.O. Box 1011, 1000 AA Amsterdam, The Netherlands  
**CANON FRANCE PHOTO CINEMA S.A.**  
20 Boulevard des Capucines, 75 001 Paris, 75111 Paris cedex 01, France  
**CANON S.R.L.**  
Via S. Rocco, 1, 20122 Sesto San Giovanni, Milan, Italy  
**CANON EURO PHOTO CINEMA**  
Lindendreef 111, 1105 AB Amsterdam, The Netherlands
- CENTRAL & SOUTH AMERICA**  
**CANON LATIN AMERICA, INC. CENTRO DE VENTAS**  
Avenida 1021, Caracas 10, Venezuela, C.A.  
**CANON LATIN AMERICA, INC. CENTRO DE SERVICIO Y REPARACION**  
Avenida 20 16, Zona 14 de Centro, Republica de El Salvador  
**CANON SINGAPORE TRADING CO., LTD.**  
Cecil Street, Singapore 0491, SINGAPORE
- INDONESIA**  
**CANON BUKIT TIMUR PTY. LTD.**  
15, Jalan Merdeka, Medan 21111, Indonesia
- ITALY**  
**CANON ALBAINIA PTY. LTD.**  
Via S. Rocco, 1, 20122 Sesto San Giovanni, Milan, Italy
- JAPAN**  
**CANON S.E.I. CO., INC.**  
1-1, Honcho 1-Chome, Bunkyo-ku, Tokyo 113, Japan

PUB.C-IE-108P  
0865B30

©CANON INC. 1984  
CY8-8007-002

PRINTED IN JAPAN



# Canon T-70

## Documentation Project



<http://www.geocities.com/Yosemite/Falls/1133/>